

## 6 Megapixel Indoor/Outdoor Fisheye IR IP Cameras

HFD6GR1

Honeywell is taking quality and reliability to the next level with the new equIP® line of fisheye IP cameras. The Honeywell outdoor TDN superior HD IR fisheye cameras offer incomparable picture clarity, an incredibly wide coverage area, hassle-free flexible system integration, and secure data transmission—and they install easily too!

### Superior Image Quality

- Full HD 6 megapixel 25/30 fps image with a 1/1.8" 6 megapixel sensor
- Digital WDR (DWDR) ensures glare-free images
- True Day/Night provides vivid colour images by day and clear black-and-white images at night using a removable IR cut filter
- Image dewarping makes the fisheye output easy to view and scan for intruders
- Embedded PTZ control within the fisheye video allows users to control the part of the 360° view to focus on
- Excellent low-light performance with 3D noise reduction, saving storage and bandwidth together with H.265 Profile codec

### Flexible Surveillance Solution

- 1.7 mm, F2.0, fixed fisheye lens
- H.265, H.264 and MJPEG codec, triple stream support
- IR LEDs provide up to 8 m (25 ft) of illumination in dimly lit or nighttime scenes (depending on scene reflectance)
- Smart IR technology provides even distribution of IR
- Waterproof (IP67) and IK10 impact-resistant camera housing
- -30°C to 60°C (-22°F to 140°F) working temperature
- ONVIF Profile S and G compliant
- Security features include individual signed certificates and data encryption
- Cameras can be retrofitted on many existing NVR installations without requiring additional storage

### Easy to Install and Use

- Built-in PoE (Power over Ethernet) eliminates separate power supply and associated wiring; 12 V DC inputs where PoE power is unavailable
- Remote configuration through web client or from the NVR
- Included accessories: security screw driver, mounting screws, mounting template, mount adapter, IR led cover, and waterproof joint for network cable



### Onboard Video Storage

Supports up to 128 GB microSDHC (Class 10) card for local video storage when network is interrupted. Card not included.

### Market Opportunities

These fully featured attractive cameras are perfect for outdoor installations that require excellent picture quality at minimal bandwidth while offering maximum protection against dust, dirt, and water. Boasting a sleek modern design and offering the widest angle of view possible, the cameras are suited for a wide range of applications.

## FEATURES AND BENEFITS







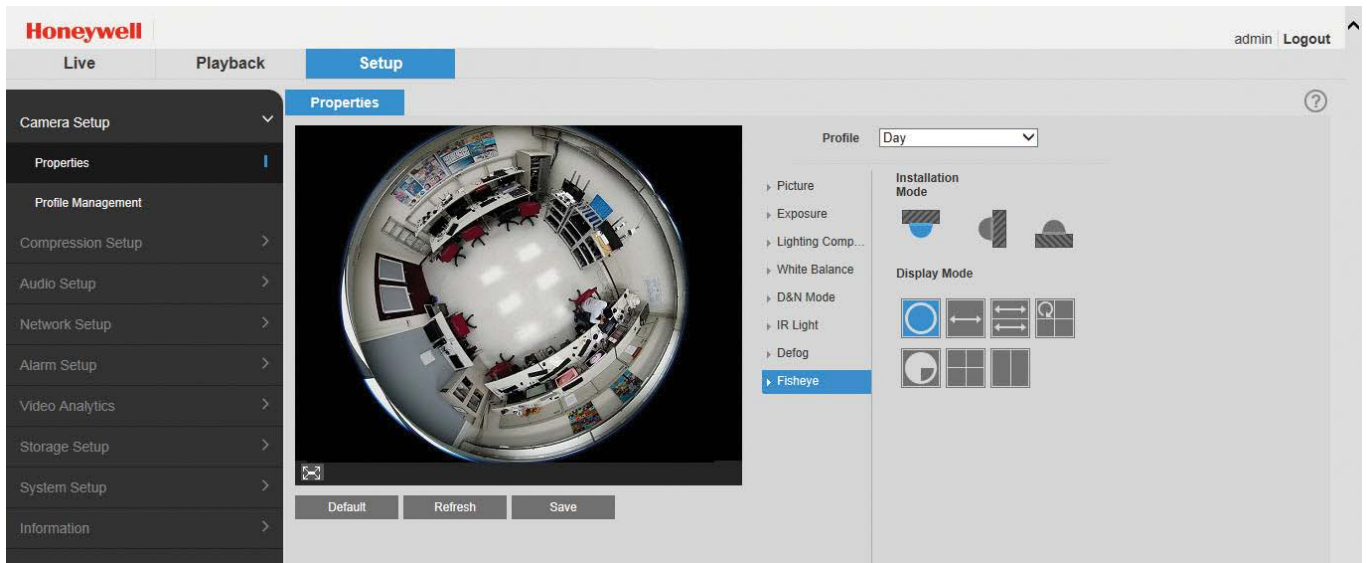



- 1/1.8" 6 megapixel progressive scan imager
- 16x digital zoom
- Digital WDR
- 8 m (25 ft) IR distance, depending on scene reflectance
- Wide horizontal angle of view at 185°
- Built-in cybersecurity hardware chipset
- Excellent low-light performance down to 0 lux BW (with IR LEDs on)
- Up to triple stream support
- 6 megapixel resolution at 25/30 fps
- 1.7 mm, F2.0, fixed fisheye lens
- Global language support with 15 languages for all QIGs, Web GUI, and online help
- Rugged outdoor housing with IP67 ingress protection rating and IK10 impact resistance rating
- ONVIF profile S and G compliant
- Onboard camera storage up to 128 GB microSD card (not included)
- Image dewarping and embedded PTZ controls for full monitoring of entire 360° fisheye view

# HFD6GR1 Features

The camera can be configured to automatically detect and respond to events such as motion in the scene, alarm inputs, network failure, and/or camera tampering. Automated responses include: sending a notification through email, FTP, and/or HTTP; sending a still image of the event through email and/or FTP; and recording a video clip of the event to a configured microSDHC card. Setup can be done through the web client.



## Fisheye Display Options and Installation Modes

	Ceiling Installation Mode		Double Panorama Image Display Mode (two 180° views in panoramic layouts)
	Wall Installation Mode		Original 360° Image with Three EPTZ (virtual PTZ) Region Images Display Mode
	Floor Installation Mode		Single Image Display Mode (displays a single view from within the 360° view)
	Original 360° Image Display Mode		Four EPTZ Region Images Display Mode
	Single Panorama Image Display Mode (360° view in a panoramic layout)		Two Vertical Panorama Images Display Mode

## Dimensions

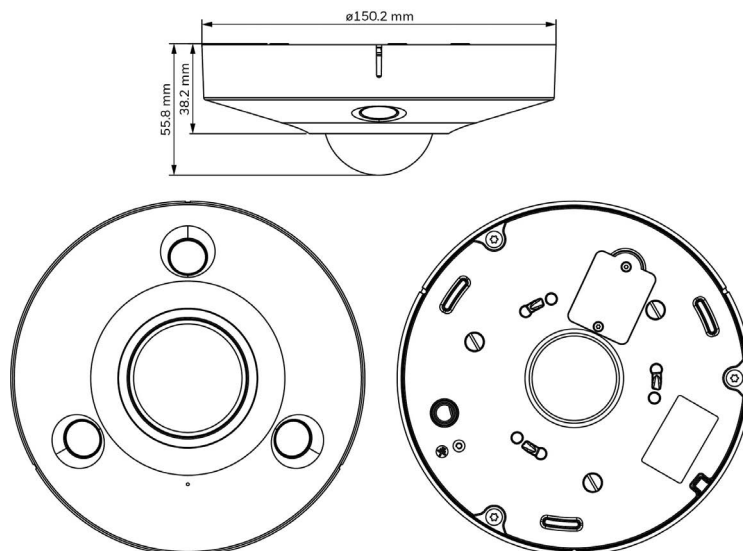





# HFD6GR1 Technical Specifications

OPERATIONAL	
Video Standard	NTSC/PAL
Scanning System	Progressive scan
Image Sensor	1/1.8" 6 MP progressive CMOS
Number of Pixels (H×V)	3072 × 2048
Minimum Illumination	0.01 lux colour/0 lux BW with IR LEDs on @ F2.0
S/N Ratio	50 dB
Electronic Shutter Speed	Auto, Manual, 1/3(4)-1/100 000 s
IR Distance	Up to 8 m (25 ft), depending on scene reflectance
IR Light Control	Smart IR/Manual/Off
Day/Night	Auto(ICR)/Colour/BW
Backlight Compensation	BLC/HLC/DWDR
Wide Dynamic Range	Digital WDR (DWDR)
White Balance	Auto/Natural/Street Lamp/ Outdoor/Customize Region
Gain Control	Auto/Manual
Noise Reduction	3DNR
Privacy Masking	Up to 4 areas
Corridor Mode	Yes
Focus Mode	Manual
Lens	1.7 mm, fixed fisheye lens, F2.0
Horizontal Angle of View	185°
Audio/Two-Way	Line In/Out, 1 built-in mic
Alarm Input/Output	2/2
Ethernet	RJ-45 (10/100/1000Base-T)
IP SPECIFICATIONS	
Video Compression	H.265/H.264/MJPEG Bit rate control (CBR and VBR)
Resolution	4:3 3MP (2048×1536) / UXGA (1600×1200) / 1.3MP (1280×960)
	Other 6MP (3072×2048) / 4MP (2048×2048) / D1 (704×576/704×480) / CIF (352×288/352×240)
	Main Stream 6MP (3072×2048) / 4MP (2048×2048) / 3MP (2048×1536) / UXGA (1600×1200) at up to 25/30 fps
Frame Rate	Sub Stream D1/CIF up to 25/30 fps
	Triple Stream 1.3MP/D1 up to 25/30 fps
Dewarping Mode	Original, Panoramic, Double Panoramic, 1+3 EPTZ, 4 Pictures, 2 Pictures, Single
Audio Compression	G.711a/G.711Mu/AAC/G.726/MPEG2-Layer2/ G.722.1/G.729
Audio Stream	Full duplex, simplex
SD Card Function	Event trigger recording Continuous and scheduled recording Automatic recording when network fails
SD Card	Up to 128 GB microSDHC card Class 10 (not included)

IP SPECIFICATIONS (CONT'D)	
Protocols*	IPv4/v6, TCP/IP, UDP, RTP, RTSP, HTTP, HTTPS, SSL, ICMP, FTP, SMTP, DHCP, PPPoE, UPnP, IGMP, SNMP, Bonjour, DNS, DDNS, IEEE 802.1X, QoS, NTP, IP Filter, Multicast, ONVIF
Compatibility	ONVIF Profile S/G
Max. User Access	20 users
Supported Web Browsers	Internet Explorer (11.0+), Firefox, Chrome
Supported OS	Windows 7 32-bit/64-bit, Windows 10
Security	Multiple user access levels with enhanced password policy, IP filtering, IEEE 802.1X, strong digest authentication for access permission, HTTPS, TLS1.2 only, high-strength encrypted algorithm AES-256, SSH/Telnet closed, FTP disabled to reduce surface being attacked, PCI-DSS compliant, built-in cybersecurity hardware chipset
Languages Supported	English, Arabic, Czech, Dutch, French, German, Italian, Japanese, Korean, Polish, Portuguese, Russian, Simplified Chinese, Spanish, Turkish
ELECTRICAL	
Power Supply	PoE (802.3af) Class 0, 12 V DC
Power Consumption	10 W max. (IR LEDs on)
MECHANICAL	
Dimensions	ø150.2 × 55.8 mm (ø5.9 × 2.2 in.)
Product Weight	1.1 lb (0.5 kg)
Construction	Die-cast aluminum housing with powder coat
Construction Colour	RAL9003 (White)
ENVIRONMENTAL	
Temperature	-30°C to 60°C (-22°F to 140°F)
Relative Humidity	Less than 95%, non-condensing
Ingress Protection	IP67
Impact Resistance	IK10
REGULATORY	
Emissions	EN 55032, FCC Part 15B AS/NZS CISPR 22:2009+ A1 (2010)
Immunity	EN 50130-4
Safety	EN 60950-1 UL Listed to UL/CSA 60950-1
RoHS	EN 50581

\*Some development may be required in specific user cases to support some of these protocols in the field as they mature over time.

# ORDERING

SYSTEM INTEGRATION		ACCESSORIES	
OPEN IP INTEGRATION		MOUNTS	
<p>ONVIF support and open API software integration. Refer to <a href="http://www.onvif.org">www.onvif.org</a> for the ONVIF specification and the Honeywell Open Technology Alliance website (<a href="http://www.security.honeywell.com/hota/">http://www.security.honeywell.com/hota/</a>) to learn more about our open and integrated solutions.</p>			
		HFG-WK	 Wall Mount Bracket
		HFG-PK	 Pendant Mount Bracket
		HB4G-PM	 Pole Mount Adapter
		HB34G-CM	 Corner Mount Adapter

HONEYWELL DEVICE INTEGRATION	
MAXPRO® NVR FAMILY	Entry to Enterprise Level Network Video Recorders (version 4.0 and greater)
MAXPRO® VMS FAMILY	Entry to Enterprise Level Network Video VMS (version R410 and greater)
DVM	DVM R600.1 SP1
HUS	HUS 5.1

ORDERING	
CAMERAS	
HFD6GR1	Network TDN Superior HD IR Rugged Fisheye Camera, 1/1.8" CMOS, 6 MP, 1.7 mm Fixed Fisheye Lens, 3 IR LEDs, PoE, H.265

NOTE: Honeywell reserves the right, without notification, to make changes in product design or specifications.

## For more information

[www.honeywell.com/security/me](http://www.honeywell.com/security/me)

## Honeywell International Middle East

Sheikh Zayed Road, EMAAR Business Park  
 Building 2, Level 2, Office 201  
 PO Box 232362, Dubai, U.A.E.  
 Telephone: +971 4 4505800  
 Facsimile: +971 4 4505900  
[www.honeywell.com](http://www.honeywell.com)

HSFV-HFD6GR1-01-ME(0217)DS-E  
 February 2017  
 © 2017 Honeywell International Inc.

