

HIKVISION[®]



Network Bullet Camera
ECI-B64Z2
Quick Start Guide

Manual Illustrations and Features

Graphics (screen shots, product pictures, etc.) in this document are for illustrative purposes only. Your actual product may differ in appearance. Your product might not support all features discussed in this document.

Hikvision USA Inc., 18639 Railroad St., City of Industry, CA 91748, USA • Hikvision Canada, 4848 rue Levy, Saint Laurent, Quebec, Canada, H4R 2P1

Telephone: +1-909-895-0400 • Toll Free in USA: +1-866-200-6690 • E-Mail: sales.usa@hikvision.com • www.hikvision.com

COPYRIGHT ©2017-2018 Hangzhou Hikvision Digital Technology Co., Ltd.

ALL RIGHTS RESERVED.

Any and all information, including, among others, wordings, pictures, graphs are the properties of Hangzhou Hikvision Digital Technology Co., Ltd. or its subsidiaries (hereinafter referred to be “Hikvision”). This user manual (hereinafter referred to be “the Manual”) cannot be reproduced, changed, translated, or distributed, partially or wholly, by any means, without the prior written permission of Hikvision. Unless otherwise stipulated, Hikvision does not make any warranties, guarantees or representations, express or implied, regarding to the Manual.

About this Manual

This Manual is applicable to the ECI-B64Z2 Network Bullet Camera.

The Manual includes instructions for using and managing the product. Pictures, charts, images and all other information hereinafter are for description and explanation only. The information contained in the Manual is subject to change, without notice, due to firmware updates or other reasons. Please find the latest version in the company website (<http://overseas.hikvision.com/en/>).

Please use this user manual under the guidance of professionals.

Trademarks Acknowledgement

HIKVISION and other Hikvision trademarks and logos are the properties of Hikvision in various jurisdictions. Other trademarks and logos mentioned below are the properties of their respective owners.

Legal Disclaimer

TO THE MAXIMUM EXTENT PERMITTED BY APPLICABLE LAW, THE PRODUCT DESCRIBED, WITH ITS HARDWARE, SOFTWARE AND FIRMWARE, IS PROVIDED “AS IS,” WITH ALL FAULTS AND ERRORS, AND HIKVISION MAKES NO WARRANTIES, EXPRESS OR IMPLIED, INCLUDING WITHOUT LIMITATION, MERCHANTABILITY, SATISFACTORY QUALITY, FITNESS FOR A PARTICULAR PURPOSE, AND NON-INFRINGEMENT OF THIRD PARTY. IN NO EVENT WILL HIKVISION, ITS DIRECTORS, OFFICERS, EMPLOYEES, OR AGENTS BE LIABLE TO YOU FOR ANY SPECIAL, CONSEQUENTIAL, INCIDENTAL, OR INDIRECT DAMAGES, INCLUDING, AMONG OTHERS, DAMAGES FOR LOSS OF BUSINESS PROFITS, BUSINESS INTERRUPTION, OR LOSS OF DATA OR DOCUMENTATION, IN CONNECTION WITH THE USE OF THIS PRODUCT, EVEN IF HIKVISION HAS BEEN ADVISED OF THE POSSIBILITY OF SUCH DAMAGES.

REGARDING TO THE PRODUCT WITH INTERNET ACCESS, THE USE OF PRODUCT SHALL BE WHOLLY AT YOUR OWN RISKS. HIKVISION SHALL NOT TAKE ANY RESPONSIBILITIES FOR ABNORMAL OPERATION, PRIVACY LEAKAGE OR OTHER DAMAGES RESULTING FROM CYBER ATTACK, HACKER ATTACK, VIRUS INSPECTION, OR OTHER INTERNET SECURITY RISKS; HOWEVER, HIKVISION WILL PROVIDE TIMELY TECHNICAL SUPPORT IF REQUIRED.

SURVEILLANCE LAWS VARY BY JURISDICTION. PLEASE CHECK ALL RELEVANT LAWS IN YOUR JURISDICTION BEFORE USING THIS PRODUCT IN ORDER TO ENSURE THAT YOUR USE

CONFORMS THE APPLICABLE LAW. HIKVISION SHALL NOT BE LIABLE IN THE EVENT THAT THIS PRODUCT IS USED WITH ILLEGITIMATE PURPOSES.

IN THE EVENT OF ANY CONFLICTS BETWEEN THIS MANUAL AND THE APPLICABLE LAW, THE LATER PREVAILS.

Regulatory Information

FCC Information

Please take attention that changes or modification not expressly approved by the party responsible for compliance could void the user's authority to operate the equipment.

FCC Compliance: This equipment has been tested and found to comply with the limits for a Class B digital device, pursuant to part 15 of the FCC Rules. These limits are designed to provide reasonable protection against harmful interference in a residential installation. This equipment generates, uses, and can radiate radio frequency energy and, if not installed and used in accordance with the instructions, may cause harmful interference to radio communications. However, there is no guarantee that interference will not occur in a particular installation. If this equipment does cause harmful interference to radio or television reception, which can be determined by turning the equipment off and on, the user is encouraged to try to correct the interference by one or more of the following measures:

- Reorient or relocate the receiving antenna.
- Increase the separation between the equipment and receiver.
- Connect the equipment into an outlet on a circuit different from that to which the receiver is connected.
- Consult the dealer or an experienced radio/TV technician for help.

FCC Conditions

This device complies with part 15 of the FCC Rules. Operation is subject to the following two conditions:

1. This device may not cause harmful interference.
2. This device must accept any interference received, including interference that may cause undesired operation.

EU Conformity Statement

 This product and, if applicable, the supplied accessories too are marked with "CE" and comply therefore with the applicable harmonized European standards listed under the EMC Directive 2014/30/EU, the RoHS Directive 2011/65/EU.

 2012/19/EU (WEEE directive): Products marked with this symbol cannot be disposed of as unsorted municipal waste in the European Union. For proper recycling, return this product to your local supplier upon the purchase of equivalent new equipment, or dispose of it at designated collection points. For more information see: www.recyclethis.info

 2006/66/EC (battery directive): This product contains a battery that cannot be disposed of as unsorted municipal waste in the European Union. See the product documentation for specific battery information. The battery is marked with this symbol, which may include lettering to indicate cadmium (Cd), lead (Pb), or mercury (Hg). For proper recycling, return the battery to your supplier or to a designated collection point. For more information see: www.recyclethis.info

Industry Canada ICES-003 Compliance

This device meets the CAN ICES-3 (B)/NMB-3(B) standards requirements.



Safety Instruction

These instructions are intended to ensure that user can use the product correctly to avoid danger or property loss.

The precaution measure is divided into “Warnings” and “Cautions”

Warnings: Serious injury or death may occur if any of the warnings are neglected.

Cautions: Injury or equipment damage may occur if any of the cautions are neglected.

	
Warnings Follow these safeguards to prevent serious injury or death.	Cautions Follow these precautions to prevent potential injury or material damage.



Warnings

- Proper configuration of all passwords and other security settings is the responsibility of the installer and/or end-user.
- In the use of the product, you must be in strict compliance with the electrical safety regulations of the nation and region. Please refer to technical specifications for detailed information.
- Input voltage should meet both the SELV (Safety Extra Low Voltage) and the Limited Power Source with 24 VAC or 12 VDC according to the IEC60950-1 standard. Please refer to technical specifications for detailed information.
- Do not connect several devices to one power adapter as adapter overload may cause over-heating or a fire hazard.
- Make sure that the plug is firmly connected to the power socket. When the product is mounted on a wall or ceiling, the device shall be firmly fixed.
- If smoke, odor, or noise rise from the device, turn off the power at once and unplug the power cable, and then please contact the service center.



Cautions

- Make sure the power supply voltage is correct before using the camera.
- Do not drop the camera or subject it to physical shock.
- Do not touch sensor modules with fingers. If cleaning is necessary, use clean cloth with a bit of ethanol and wipe it gently. If the camera will not be used for an extended period, please replace the lens cap to protect the sensor from dirt.
- Do not aim the camera at the sun or extra bright places. Blooming or smearing may occur otherwise (which is not a malfunction), and affect the endurance of sensor at the same time.
- The sensor may be burned out by a laser beam, so when any laser equipment is in using, make sure that the surface of sensor will not be exposed to the laser beam.

- Do not place the camera in extremely hot, cold (the operating temperature shall be -30° to +60° C, or -40° to 60° C if the camera model has an “H” in its suffix), dusty or damp locations, and do not expose it to high electromagnetic radiation.
- To avoid heat accumulation, good ventilation is required for operating environment.
- Keep the camera away from liquid while in use.
- While in delivery, the camera shall be packed in its original packing, or packing of the same texture.
- Regular part replacement: a few parts (e.g. electrolytic capacitor) of the equipment shall be replaced regularly according to their average enduring time. The average time varies because of differences between operating environment and using history, so regular checking is recommended for all the users. Please contact your dealer for more details.
- Improper use or replacement of the battery may result in hazard of explosion. Replace with the same or equivalent type only. Dispose of used batteries according to the instructions provided by the battery manufacturer.
- If the product does not work properly, contact your dealer or the nearest service center. Never attempt to disassemble the camera yourself. (We shall not assume any responsibility for problems caused by unauthorized repair or maintenance.)

Table of Contents

1 Appearance Description	0
1.1 Type I Camera	0
2 Installation	1
2.1 Memory Card Installation	1
2.2 Ceiling/Wall Mounting	2
2.3 Zoom and Focus Adjustment	4
2.3.1 Type I	4
2.3.2 Type II	4
2.4 Installation of Network Cable Water-Resistant Jacket (Optional)	5
3 Camera LAN Configuration	6
3.1 Wiring	6
3.2 Activate the Camera	7
3.2.1 Activation via Web Browser	7
3.2.2 Activation via SADP Software	8
3.3 Modify the IP Address	8
4 Access via Web Browser	9
5 Hik-Connect	11
5.1 Enable Hik-Connect for Use with Cameras	11
5.2 Enable Hik-Connect Service via SADP Software	11
5.2.1 Enable Hik-Connect via a Web Browser	12
5.3 Add Camera to Hik-Connect	12
5.4 Initialize the Memory Card	13

1 Appearance Description

1.1 Type I Camera

The overview of the type I camera is shown below.

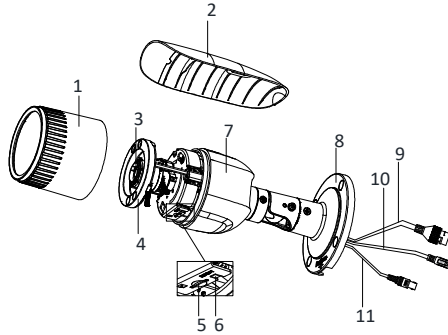

Figure 1-1 Overview of Type I Camera

Table 1-1 Description

No.	Description
1	Front Cover
2	Sun Shield
3	Lens
4	IR LED
5	Memory Card Slot
6	Reset Button
7	Camera Body
8	Bracket
9	Network Interface
10	Power Interface
11	CVBS Interface

Note:

Press RESET for 10 s when the camera is powering on or rebooting to restore the default settings, including the user name, password, IP address, port no., etc.

2 Installation

Make sure of the following before you start:

- The device included in the package is in good condition and all required parts are included.
- The standard power supply is 12 VDC or PoE (802.3af), and must be consistent with camera requirements.
- Equipment is powered-off during installation.
- The installation environment is correct.
- The wall or ceiling is strong enough to withstand four times the weight of the camera and mount.

For IR cameras, take the following precautions in order to prevent IR reflection:

- Make sure that there is no reflective surface that is too close to the camera lens. The IR light from the camera may reflect back into the lens, which may cause reflection.

2.1 Memory Card Installation

Note:

A microSD memory card is not included with the camera. You will need to purchase one separately.

This series of cameras supports memory card installation. Different camera types share similar installation steps, and we used the type II camera as an example here.

Steps:

1. Loosen the lock screw to remove the sun shield.

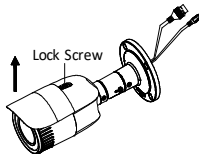

Figure 2-1 Remove the Sun Shield

2. Rotate the front cover counterclockwise in order to remove it.

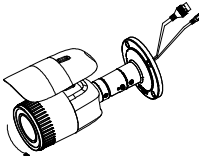

Figure 2-2 Remove the Front Cover

3. Insert the memory card into the memory card slot.

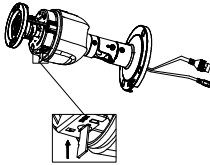

Figure 2-3 Insert the Memory Card

4. Rotate the front cover clockwise back onto the camera and replace the sun shield.
5. Tighten the lock screw clockwise to fix the sun shield.

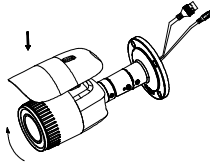

Figure 2-4 Fix the Front Cover

2.2 Ceiling/Wall Mounting

Before You Start:

These types of cameras are equipped with a bracket. They can be mounted directly to a wall or ceiling.

Steps:

1. Stick the supplied drill template to the wall or ceiling where you intend to install the camera.
2. Drill screw holes in the wall or ceiling according to the drill template.

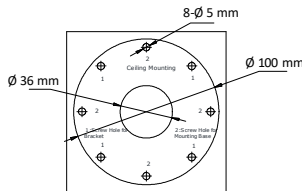

Figure 2-5 Drilling Holes in the Wall/Ceiling

3. To route the cables through the wall (or ceiling), drill a cable hole according to the drill template. Skip this step if you want to route the cables on the surface of the wall (or the ceiling).
4. Route the camera cables.
5. Secure the camera to the wall (or ceiling) with the supplied screws.

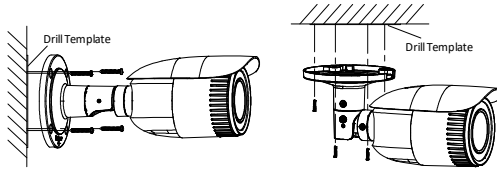

Figure 2-6 Secure the Camera

Note:

- The supplied screw package contains self-tapping screws and expansion bolts.
 - For a cement wall (or ceiling), use expansion bolts to secure the camera. For a wooden wall (or ceiling), use self-tapping screws.
6. Connect the corresponding cables, such as the power cord or network cable.
 7. Power on the camera, and set the network configuration (for further detail, refer to the **Network Camera LAN Configuration** and **Access via Web Browser** sections) to check whether the image is at an optimum angle. If not, adjust the surveillance angle.

Pan Adjustment

Steps:

- 1). Loosen lock screw 1.
- 2). Adjust the panning position of the camera. The adjusting range is from 0° to 360°.
- 3). Tighten lock screw 1.

Tilt Adjustment

Steps:

- 1). Loosen lock screw 2.
- 2). Adjust the tilting position of the camera. The adjustment range is from 0° to 90°.
- 3). Tighten lock screw 2.

Rotation Adjustment

Steps:

- 1). Loosen lock screw 3.
- 2). Rotate the rotation position to adjust the azimuth angle of the image. The adjusting range is from 0° to 360°.
- 3). Tighten lock screw 3.

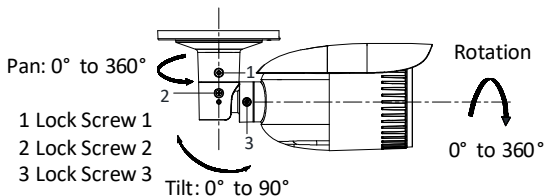

Figure 2-7 View Angle Adjustment

8. Adjust zoom and focus (refer to **2.3 Zoom and Focus Adjustment**).
9. (Optional) Install the water-resistant jacket for network interface. Refer to **2.4 Installation of Network Cable Water-Resistant Jacket (Optional)** for detailed installation procedures.

2.3 Zoom and Focus Adjustment

2.3.1 Type I

Purpose:

Use the zoom lever and focus the lever to adjust zoom and focus levels. Follow the steps below to adjust focus and zoom.

Steps:

1. Remove the sun shield and front cover to expose the zoom and focus levers.
2. View the camera image on the monitoring screen.
3. Loosen the zoom lever and move the lever between T (Tele) and W (Wide), in order to obtain the desired angle of view.
4. Tighten the zoom lever.
5. Loosen the focus lever, and move the lever between F (Far) and N (Near) to obtain the optimum focus.
6. Tighten the focus lever.
7. Install the sun shield and the front cover back onto the camera.

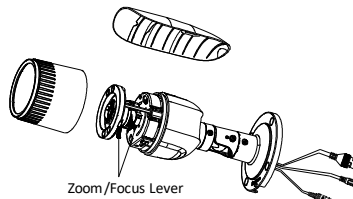

Figure 2-8 Zoom and Focus Adjustment

Note:

If the camera is equipped with a fixed lens, you don't need to adjust the zoom and focus.

2.3.2 Type II

Cameras of this type are equipped with a motorized varifocal lens. You can adjust the zoom and focus level on the PTZ control panel by visiting the camera via a Web browser or client software.

For detailed steps, refer to the network camera user manual.

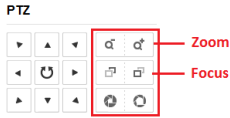

Figure 2-9 Zoom and Focus Adjustment via Web Browser

2.4 Installation of Network Cable Water-Resistant Jacket (Optional)

Purpose:

If the camera is installed outdoors, you can connect a water-resistant accessory to the network cable to protect it from water accumulation.

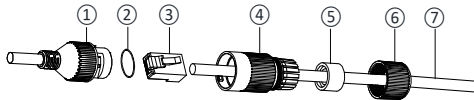

Figure 2-10 Waterproof Accessory Components

Table 2-1 Components

No.	Components
1	Network Interface Socket
2	O-Type Gasket
3	Network Plug
4	Water-Resistant Endcap
5	Water-Resistant Rubber Gasket
6	Lock Nut
7	Network Cable from Router/Switch

Steps:

1. Feed the plugless network cable (7) through the lock nut (6), water-resistant rubber gasket (5) (the rubber gasket inset ridge must face the water-resistant endcap), and the water-resistant endcap (4).
2. Crimp an RJ-45 network plug (3) onto the end of the cable, making sure to insert the twisted pairs of wires in the correct order.
3. Place the O-type gasket (2) onto the end of the camera’s network interface socket (1).
4. Insert the network plug (3) into the camera’s network interface socket (1).
5. Insert the water-resistant rubber gasket (5) into the water-resistant endcap (4), and secure the lock nut (6) with the water-resistant endcap (4).

- 6. Align the snap on the water-resistant endcap (4) with the notch on the camera's network interface socket (1), and then secure the water-resistant endcap (4) to the camera's network interface socket (1) to finish installation.

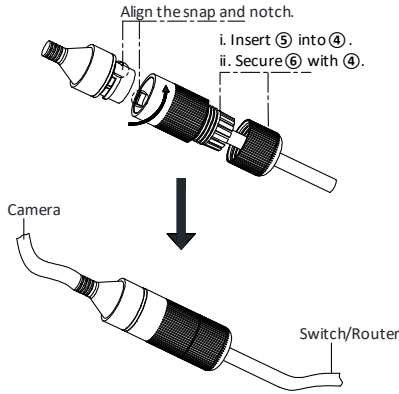

Figure 2-11 Water-Resistance Accessory Installation

3 Camera LAN Configuration

Note:

The use of products with Internet access carries inherent security risks. In order to avoid network attacks and information leakage, strengthen your own network protection. If the product does not work properly, contact your dealer or the nearest service center for help.

3.1 Wiring

Connect the camera to network as follows:

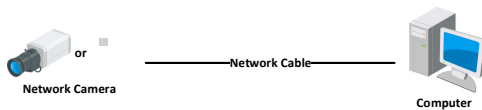

Figure 3-1 Connect Directly

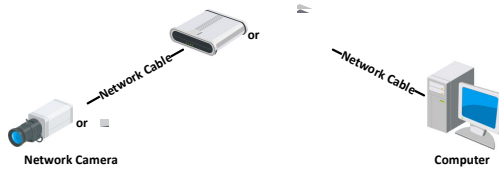

Figure 3-2 Connect via a Switch or a Router

3.2 Activate the Camera

Activate the camera by setting a strong password. Activation via web browser, activation via SADP, and activation via client software are supported. Activation via SADP software and web browser will be used as examples to introduce camera activation.

Note:

Refer to the Network Camera User Manual for activation via client software.

3.2.1 Activation via Web Browser

Steps:

1. Power the camera on. Connect the camera to your computer or the switch/router that your computer connects to.
2. Input the IP address into the address bar of the Web browser, and press **Enter** to enter the activation interface.

Notes:

- The camera’s default IP address is 192.168.1.64.
- The computer and the camera should belong to the same subnet.
- For cameras that have DHCP enabled by default, use the SADP software to search for the IP address.

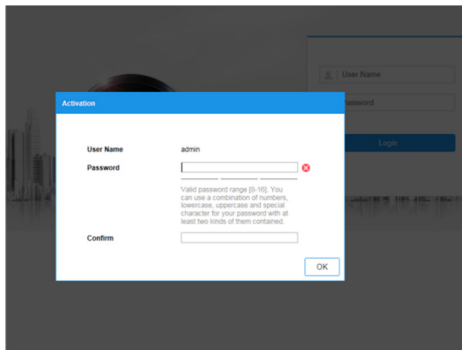



Figure 3-3 Activation Interface (Web)

3. Create and input a password.

 **STRONG PASSWORD RECOMMENDED** – We highly recommend creating a strong password of your own choosing (using a minimum of eight characters, including upper case letters, lower case letters, numbers, and special characters) in order to increase the security of your product. We recommend regularly resetting your password on a weekly or monthly basis, especially in high security systems.

4. Confirm the password.
5. Click **OK** to save the password and enter the live view interface.

3.2.2 Activation via SADP Software

SADP software is used for detecting online devices, activating cameras, and resetting passwords.

SADP can be obtained from the supplied disk or the official website, and installed by following the prompts.

Follow the steps to activate the camera.

Steps:

1. Run SADP to search for online devices.
2. Check the device status from the device list, and select the inactive device.

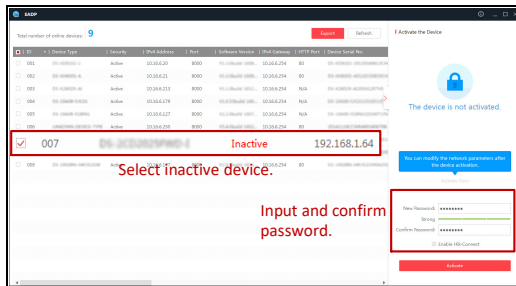

Figure 3-4 SADP Interface

Note:

SADP supports batch camera activations. Refer to the SADP user manual for further details.

3. Create, input, and confirm the password.

⚠️ STRONG PASSWORD RECOMMENDED – We highly recommend creating a strong password of your own choosing (using a minimum of eight characters, including upper case letters, lower case letters, numbers, and special characters) in order to increase the security of your product. We recommend regularly resetting your password on a weekly or monthly basis, especially in high security systems.

Note:

You can enable the Hik-Connect service for the device during activation. Refer to Chapter 5.1 for detailed information.

1. Click **Activate** to start activation.

You can check whether the activation is complete in the popup window. If activation failed, make sure that the password meets the requirements, and try again.

3.3 Modify the IP Address

Purpose:

To view and configure the camera via LAN (Local Area Network), you need to connect the network camera in the same subnet as your PC.

ECI-B64Z2 Quick Start Guide

Use the SADP software or client software to search and change the IP address of the device. IP Address modification via SADP software will be used as an example.

In order to modify the IP address via client software, refer to the user manual of the client software.

Steps:

1. Run SADP.
2. Select an active device.
3. Change the device IP address to the same subnet as your computer by either modifying the IP address manually, or by checking the **Enable DHCP** checkbox.

Modify Network Parameters

Enable DHCP
 Enable Hik-Connect

Device Serial No.: XX-XXXXXXXX-XXXXXXXXXXXXXXXX

IP Address: 192.168.1.64

Port: 8000

Subnet Mask: 255.255.255.0

Gateway: 192.168.1.1

IPv6 Address: ▾

IPv6 Gateway: ▾

IPv6 Prefix Length: 0

HTTP Port: 80

Security Verification

Admin Password:

Modify

[Forgot Password](#)

Figure 3-5 Modify the IP Address

Note:

Hik-Connect can be enabled during activation. Refer to Chapter 5.1 for detailed information.

4. Input the admin password and click **Modify** to complete IP address modification.

SADP supports batch IP address modification. Refer to the SADP user manual for details.

4 Access via Web Browser

System Requirement:

Operating System: Microsoft Windows XP SP1 and above

CPU: 2.0 GHz or greater

RAM: 1 GB or greater

Display: 1024×768 resolution or higher

ECI-B64Z2 Quick Start Guide

Web Browser: Internet Explorer 8.0 or higher, Apple Safari 5.0.2 or higher, Mozilla Firefox 5.0 or higher, or Google Chrome 18 or higher

Steps:

1. Open the Web browser.
2. In the browser address bar, input the IP address of the network camera, and press the **Enter** key to enter the login interface.

Note:

The default IP address is 192.168.1.64. It is suggested that you change the IP address to the same subnet as your computer.

3. Input the user name and password.

The admin user should configure the device accounts and user/operator permissions properly. Delete the unnecessary accounts and user/operator permissions.

Note:

The device IP address gets locked if the admin user performs seven failed password attempts (five attempts for the user/operator).

4. Click **Login**.



Figure 4-1 Login Interface

5. Install the plug-in before viewing the live video and managing the camera. Follow the installation prompts to install the plug-in.

Note:

You may have to close the Web browser to complete plug-in installation.

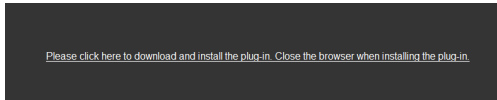

Figure 4-2 Download Plug-in

6. Reopen the Web browser after plug-in installation and repeat steps 2 to 4 in order to login.

Note:

For further configuration instructions, please refer to the network camera user manual.

5 Hik-Connect

Purpose:

Hik-Connect is a mobile application to view live camera images, receive alarm notifications, etc.

5.1 Enable Hik-Connect for Use with Cameras

Purpose:

Enable Hik-Connect should on your camera before using the service. You can enable the service either via SADP software or a Web browser.

5.2 Enable Hik-Connect Service via SADP Software

Steps:

1. Check the **Enable Hik-Connect** checkbox:
 - 1). For the “Activate the Device” page that appears during camera activation, refer to Chapter 3.2.2.
 - 2). For the “Modify Network Parameters” page that appears while modifying the IP address, refer to Chapter 3.3.
2. Create or change the verification code.

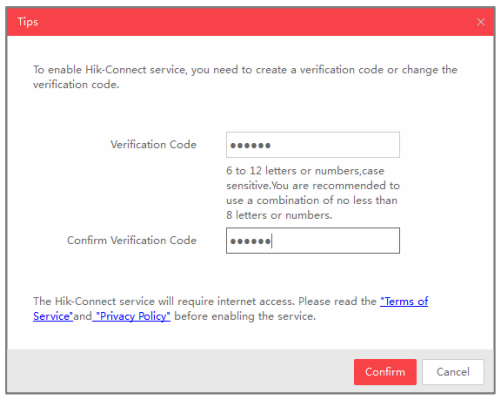

Figure 5-1 Verification Code Setting (SADP)

Note:

The verification code is required when adding the camera to Hik-Connect.

3. Click and read the “Terms of Service” and “Privacy Policy.”
4. Confirm the settings.

5.2.1 Enable Hik-Connect via a Web Browser

Before You Start:

Activate the camera before enabling the service. Refer to Chapter 3.2. for more information.

Steps:

1. Access the camera via the Web browser. Refer to Chapter 4.
2. Enter the platform access configuration interface, as follows: **Configuration > Network > Advanced Settings > Platform Access.**

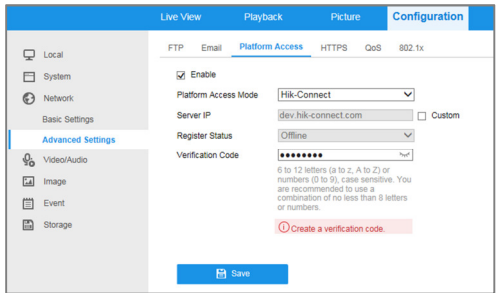

Figure 5-2 Platform Access Configuration (Web)

3. Set the **Platform Access Mode** to **Hik-Connect**.
4. Check the **Enable** checkbox.
5. Click and read the “Terms of Service” and “Privacy Policy” in the pop-up window.
6. Create or change the verification code for the camera.

Note:

A verification code is required when you add the camera to Hik-Connect.

7. Save the settings.

5.3 Add Camera to Hik-Connect

Before You Start:

Enable Hik-Connect on the camera before adding it to your Hik-Connect account. See Chapter 5.1.

Steps:

1. Use a network cable to connect camera to a router if the camera does not support Wi-Fi.



Figure 5-3 Connect a Router

Note:

After the camera connects to the network, wait one minute before using the camera with Hik-Connect.

2. Add the camera to the Hik-Connect app:

- **If Accessing the Camera through an NVR:** Tap “+” on the upper-right corner and scan the QR code that appears in the NVR interface.
- **If Accessing the Camera through a Web Browser:** Tap the  icon and type in the camera’s serial number.

3. Input your camera’s verification code.

Note:

The required verification code is created or changed when you enable Hik-Connect on your camera.

Forgotten verification codes can be recovered in the **Platform Access** configuration page via the web browser.

4. Follow prompts to set up the network connection and add the camera to your Hik-Connect account.

Note:

For detailed information, refer to the Hik-Connect user manual.

5.4 Initialize the Memory Card

Note:

The microSD memory card is not included with the camera and must be purchased separately.

Steps:

1. Check the status of the memory card by tapping on the Storage Status in the Device Settings interface.
2. If the memory card status displays as Uninitialized, tap to initialize it. The status will then change to Normal. You can then start recording any event-triggered video in the camera such as motion detection-generated videos.

